

190-ACC Horizontal Power Conveyor (Accumulating Type)

The simplest method ever devised for accumulating cartons, boxes, etc. Basic design eliminates complicated adjustments and allows a minimum 2% back pressure.

- 12 Bed Widths
- 2% Minimum Back Pressure
- Finger Tip Snub Roller Adjustment, No Tools Needed
- Reversible
- Adjustable MS-Type Floor Supports Available



Conveyor shown with optional floor supports

SIZE TO ORDER Overall Length "A"	Between Rail Width	13"	15"	17"	19"	21"	23"	25"	27"	31"	33"	37"	39"
	Overall Frame Width	16"	18"	20"	22"	24"	26"	28"	30"	34"	36"	40"	42"
5'		231	238	252	263	277	289	299	314	337	350	375	387
10'		370	384	410	429	455	477	495	522	564	588	633	655
15'		509	530	568	595	633	665	691	730	791	826	891	923
20'		648	676	726	761	811	853	887	938	1018	1064	1149	1191
25'		787	822	884	927	989	1041	1083	1146	1245	1302	1407	1459
30'		926	968	1042	1093	1167	1229	1279	1354	1472	1540	1665	1727
35'		1065	1114	1200	1259	1345	1417	1475	1562	1699	1778	1923	1995
40'		1204	1260	1358	1425	1523	1605	1671	1770	1926	2016	2181	2263
45'	WEIGHTS (Lbs.)	1343	1406	1516	1591	1701	1793	1867	1978	2153	2254	2439	2531
50'	Weights	1482	1552	1674	1757	1879	1981	2063	2186	2380	2492	2697	2799
55'	Based on	1621	1698	1832	1923	2057	2169	2259	2394	2607	2730	2955	3067
60'	3" Roller	1760	1844	1990	2089	2235	2357	2455	2602	2834	2968	3213	3335
65'	Centers	1899	1990	2148	2255	2413	2545	2651	2810	3061	3206	3471	3603
70'		2038	2136	2306	2421	2591	2733	2847	3018	3288	3444	4503	3871
75'		2177	2282	2464	2587	2769	2921	3043	3226	3515	3682	3987	4139
80'		2316	2428	2622	2753	2947	3109	3239	3434	3742	3920	4245	4407
85'		2455	2574	2780	2919	3125	3297	3435	3642	3969	4158	4503	4675
90'		2594	2720	2938	3085	3303	3485	3631	3850	4196	4396	4761	4943
95'		2733	2886	3096	3251	3481	3673	3827	4058	4423	4634	5019	5211
100'		2872	3012	3254	3417	3659	3861	4023	4266	4650	4872	5277	5479



Conveyor shown with featured option - shaft mounted drive.

SPEED FPM	MAX HP	MOTOR FRAME
26	1/2	56C
32	1	56C
43	1	56C
52	1	56C
64	2	140TC
86	2	140TC
103	2	140TC
129	2	140TC
*172	2	140TC
*257	2	140TC
*343	2	140TC

All weights in catalog are conveyor weights only. Accessories, crating, etc., are not included.

NOTE: Stockyard drives are located on 10 ft beds only.

NOTE: 16", 20", 22", 26", 28", 34", 36", 40" & 42" Overall Frame Widths - 1 Week Stockyard

NOTE: Intermediate bed sections are available in multiples of 4 ft., 5 ft., 6 ft., 7 1/2 ft., 8 ft., and 10 ft lengths only.

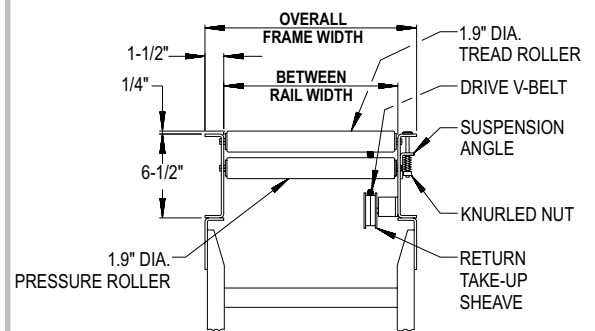
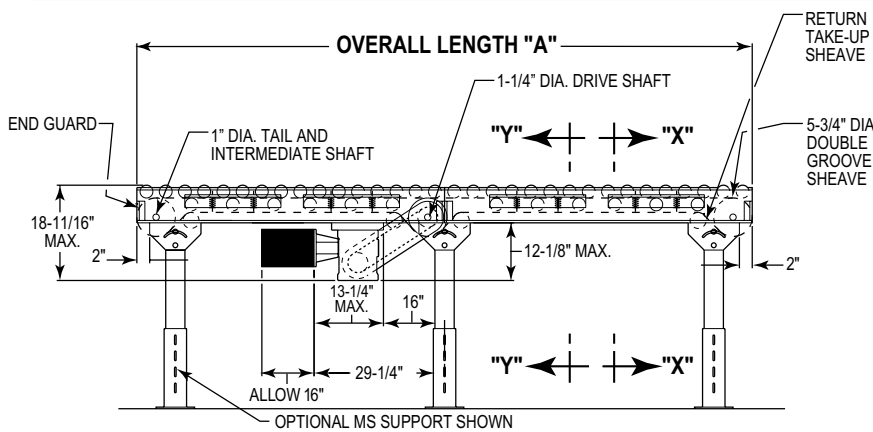

SECTION "X-X"

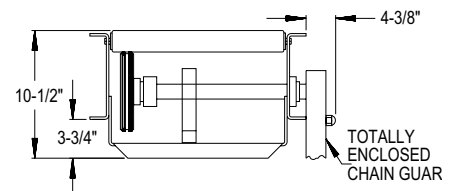
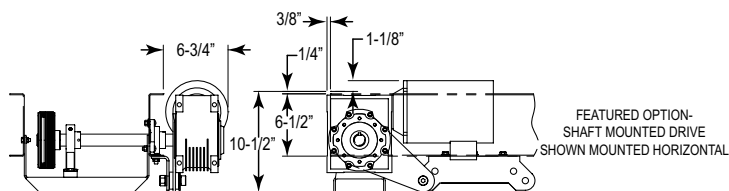

SECTION "Y-Y"



• STANDARD SPECIFICATIONS

BED—Roller bed with 1.9 in. dia. roller x 16 ga. galvanized tube spaced every 3 in. and 1.9 in. dia. pressure rollers x 16 ga. galvanized tube spaced every 6 in. Mounted in 6 1/2 in. x 12 ga. powder painted formed steel channel frame bolted together with butt couplings.

CROSS BRACING—Rods with turnbuckles are fastened to underside of bed to provide proper alignment of bed rollers and insure tracking. (1) supplied in first 50' of bed section lengths and (1) per 50' of bed section length thereafter. Supplied in approximate center of lengths.

DRIVE—Mounted underneath, placed near center of conveyor.

DRIVE BELT—Endless B-section aramid core V-Belt drives each section of conveyor.

RETURN TAKE-UP SHEAVE—3 1/4 in. dia. x 1/2 bore flat idler has seven position adjustment to maintain proper V-belt tension.

BEARINGS—Tread & pressure rollers have pre-lubricated ball bearings. Flange and pillow block bearings are sealed, pre-lubricated with eccentric lock collar.

SPEED REDUCTION—Sealed worm gear C-Face speed reducer. No. 50 roller chain to drive shaft.

MOTOR—1/2 HP—208/230/460/575V—3 Ph. 60 Hz. Totally Enclosed C-Face.

CONVEYING SPEED—Constant 25 - 120 FPM.

CAPACITY—Maximum load per linear foot of conveyor 150 lbs. NOT TO EXCEED capacity in chart.

FLOOR SUPPORTS—Now supplied as optional equipment.

• HOW IT WORKS

The driving of the tread rollers on the HYTROL minimum pressure conveyor is accomplished with the top surface of a standard section endless flat belt. The strength and wear qualities of the tread rollers and this belt have been thoroughly tested for continuous duty.

To maintain the driving of the tread roller, the pressure roller is mounted in spring adjusted carriers (See Photo) which sense the required driving friction regardless of the length of accumulated load. This pressure can be maintained constantly to give a 2% minimum back pressure in either a forward or reverse direction.

In the event of extreme changes in unit load (weight of box or package), convenient knurled thumb adjusting nuts can be turned to accept this heavier load.

This method eliminates the need for selecting proper tension spring holes in trigger mechanisms or jogging cleats on driving belt and eccentric (off center) tread rollers.

By maintaining a constant minimum pressure on the tread rollers, long loads may be conveyed, accumulated or stopped on the conveyor at any point using very little motor horsepower and giving practically no pressure between boxes or packages.

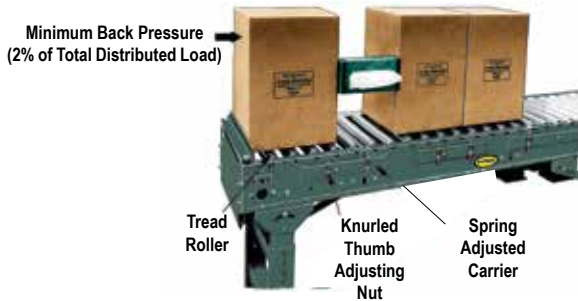

Conveyor shown with optional floor supports

LOAD CAPACITY CHART @ 65 FPM

HP	OVERALL FRAME WIDTHS 16" to 22"	OVERALL FRAME WIDTHS 24" to 30"	OVERALL FRAME WIDTHS 34" to 42"
	TOTAL LOAD (Lbs.) UP TO 100'	TOTAL LOAD (Lbs.) UP TO 100'	TOTAL LOAD (Lbs.) UP TO 100'
1/2	1000	800	500
1	2400	2200	2000
2	3500	3000	2600

• OPTIONAL EQUIPMENT

FLOOR SUPPORTS—MS Type floor supports are available with a wide range of adjustment. Specify top of belt or roller elevation. One support required at every bed joint and ends of conveyor. Holes in feet for lagging to floor. Knee braces recommended above MS-6 support.

CONVEYING SPEED—Other constant speeds from 25 to 120 FPM. V-belt drive supplied under 56 FPM (with 1 HP). **NOTE:** Capacity and accumulation feature affected with speed change.

SHAFT MOUNTED DRIVE—Motor reducer unit mounted on extended drive shaft. Can be mounted with standard sheave retainer for 10 1/2 in. elevation (motor horizontal), or can be mounted with low elevation sheave retainer for 8 3/4 in. elevation (motor vertical). Mounting bracket and torque arm allows for multiple mounting positions. See above chart for speeds.

SIDE MOUNTED DRIVE—Motor reducer unit mounted to side of conveyor. Elevation 10 1/2 in. with standard sheave retainer. 9 3/8 in. elevation at drive, 8 3/4 in. elevation at intermediate when low elevation sheave retainer used.

V-BELT DRIVE—V-belt supplied between motor and reducer.

O-RING DRIVE CHAIN—With sealed in lubricant (Recommended for applications that do not permit regular lubrication).

PACKAGE STOPS—Roller or pin type stops available.

GUARD RAILS—Adjustable Universal Channel Guard Rail, fixed channel, type A & B angle. (See Accessory section.) **NOTE:** If product comes in contact with guard rails, product flow will be affected. Fixed channel overlapping, one direction. Fixed channel non-overlapping, reversing.

ROLLER CENTERS—Tread rollers spaced every 2 in. and 4 in. (NOT AVAILABLE in 7 ft. 6 in. bed).

SPRING BALANCED GATE—See 190-E24G powered or gravity die spring balanced gate.

POLY-TIER SUPPORTS—36 in. to 120 in. support heights in 6 in. increments. Knee braces supplied.

CEILING HANGERS—5/8 in. dia. x 8 ft. long unplated rods fully threaded. Other lengths and galvanized rods available.

MOTORS—Energy efficient, single phase, brakemotor, other characteristics. 2 HP maximum.

ELECTRICAL CONTROLS—Non-reversing or reversible magnetic starters and push-button stations. AC variable frequency drive.